CHAPTER - II

PREPARATION AND X-RAY

DIFFRACTION STUDIES OF SAMPLES

C H A P T E R - I IPREPARATION AND X-RAY DIFFRACTION STUDIES OF SAMPLES2.1 Introduction :

Ferroelectric materials in various forms such as single crystal, ceramic, thin film and glass have been found useful. For basic studies, where the polar materials should be as perfect as possible, it is desirable to use single crystals. For applications, where dimensions and cost are important factors, polar materials in ceramic, thin film or glass form are usually used without unduly affecting the reproducibility. Some materials cannot be easily grown as single crystals and hence the ceramic form has to be used even for the basic studies.

The useful technique of ceramic preparation is by sintering at higher temperatures and in suitable atmosphere. The constituent compounds or oxides are mixed in correct proportions and then pressed at room temperature into a pellet of required shape and dimensions. The pellet is sintered or fired at an appropriately high temperature in an appropriate atmosphere. This causes the constituent materials to exhibit solid state reaction and to form the desired ferroelectric material, which can be shaped easily beforehand. Under suitable conditions, the ceramic body can

be polarized in any given direction by a strong dc field. These ceramics can then be used as electro-mechanical transducers in a number of applications.

Work on ceramic method of preparation and properties of vanadates, metavanadates and related compounds has been carried out by various workers [Glazyrin et al (1964), Sorum (1943), Feigelson et al (1972), Ramani et al (1975), Shaikh et al (1978), Seetharam et al (1983), Patil et al (1988 a,b), Godefrog et al (1981) and Hawthorne et al (1977)].

Preparation of NaVO_3 and its doped compositions using the ceramic method is discussed in this chapter. X-ray diffraction studies on these samples is also presented.

2.2 Preparation of Sodium Vanadate :

Sodium vanadate was prepared by using stoichiometric mixture of Na_2CO_3 and vanadium pentoxide (V_2O_5) for sintering. The starting chemicals viz. sodium carbonate and vanadium pentoxide were of analar grade from K.Chem.Chemicals and Fluka A.G. Switzerland. The following reaction may be said to be taking place associated with sintering.

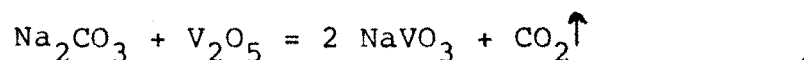

However, if the temperature of the mixture is higher than decomposition temperature of the carbonate, the carbon dioxide escapes and the oxides react to give sodium vanadate.

Sodium carbonate was baked at a temperature of 200°C for 2 hours before weighing in order to remove moisture content. The stoichiometric mixture of the sodium carbonate and V_2O_5 was slowly heated in a platinum crucible in a global furnace and fired at temperature 750°C for 4 hours and then cooled gradually to room temperature.

2.3 Preparation of $NaVO_3$ doped with Fe_2O_3 :

Sodium vanadate was doped with Fe_2O_3 of purity 99.9% (John Baker Inc. Colorado, USA). The samples were prepared by taking a quantity of Fe_2O_3 so as to give 0.025, 0.1, 0.5, 1.0, 3.0 and 5.0 mol.% in $NaVO_3$. Every batch of each percentage was subsequently dry-mixed and then wet-mixed with ethyl alcohol. After complete evaporation of the alcohol the batches were heated in a platinum crucible at 900°C for 5 hours in a global furnace for reaction in molten state and were allowed to cool down gradually to room temperature. All samples were then ground to fine powder form so as to pass through a 120 mesh sieve. The pellets of these samples were prepared in the form of discs of 0.25 cm thickness and 1.0 cm diameter by applying 7.0×10^7 Kg/m² pressure using a hydraulic press. These pellets were sintered on a platinum foil at 500°C for 4 hours in a furnace and used for experimental investigations.

2.4 Structural Characteristics :

Ramani et al (1975) reported that $NaVO_3$ belongs to

monoclinic system with space group C_c at the room temperature, while the space group in the high temperature paraelectric phase is C_2/c . Sodium vanadate belongs to the pyroxene family and has infinite linear chains of VO_3^- formed by VO_4 tetrahedra sharing two corners with neighbours, the chains being held together by sodium ions. A typical form of such a chain along the C-axis is shown in Fig.2.1. The crystal structure may be viewed as consisting of alternate channels of sodium polyhedra and linear chains of VO_3^- ions (Fig.2.2). Each Na ion is surrounded by six oxygens forming an octahedral co-ordination. The co-ordination polyhedron around the sodium atom is nearly a regular octahedron. Seetharam et al (1983) confirmed the C_c ferroelectric space group in the room temperature phase from the Raman spectroscopic studies.

2.5 X-ray Diffraction Studies :

2.5.1 Introduction :

It is well known that x-ray diffraction is an established and indispensable tool to study the formation of solids and solid solutions. Therefore, the x-ray diffraction studies were carried out with a view to check the formation of $NaVO_3$ and its compositions with the help of changes in lattice parameters.

Through the work of Bragg, Laue and others, it became known that in crystalline material of any crystallographic

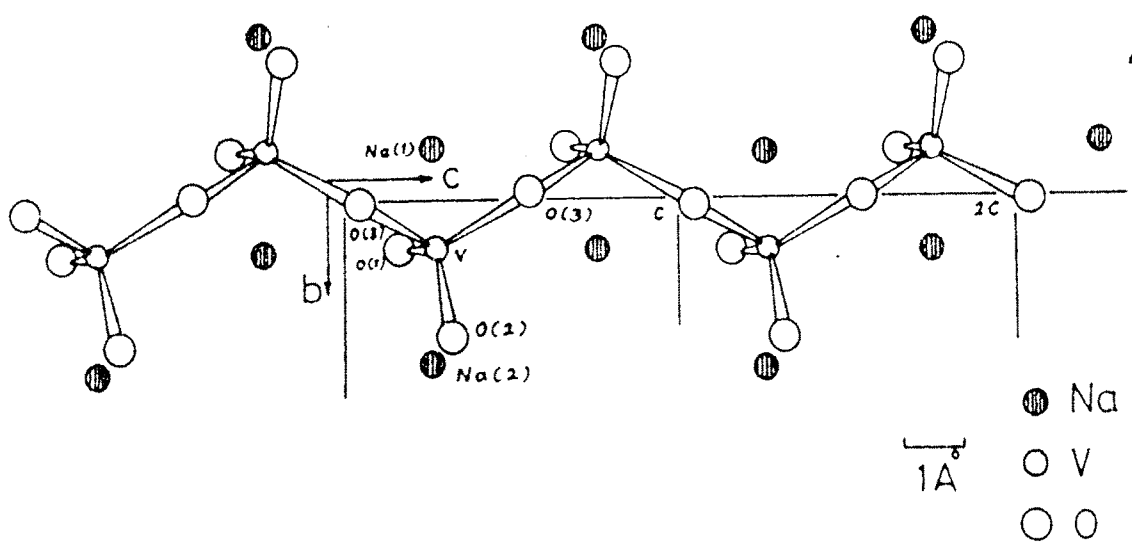

Fig. 2-1 A view of the infinite linear chain of VO_4 tetrahedra along the c-axis. Only one such chain is shown for clarity

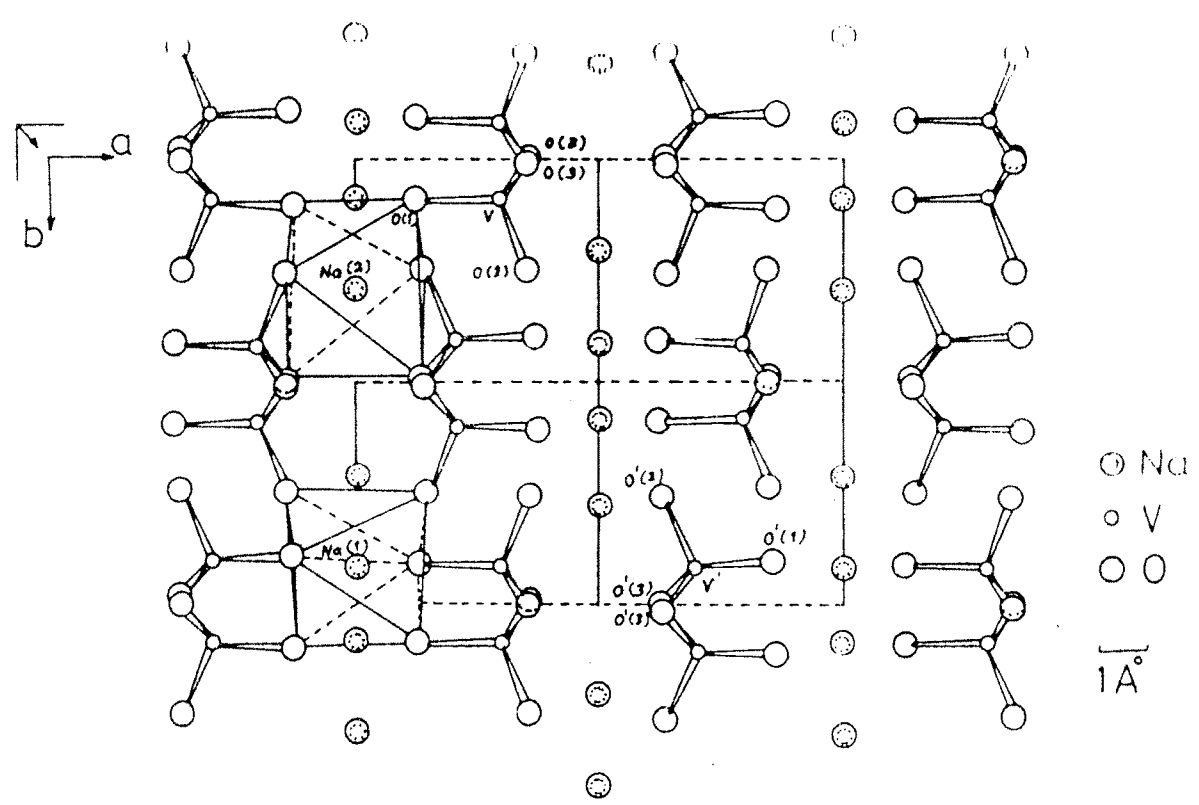

Fig. 2-2 A view of the structure looking down the (001) direction. The octahedral co-ordination around sodium ions Na(1) and Na(2) is shown. All the octahedra are not shown for clarity

system and having some Bravais lattice, the lattice parameters happen to be related to the interplaner distances of various sets of planes with different Miller indices. If (h,k,l) are Miller indices for a set of parallel planes, for monoclinic system, the interplaner distance is given by

$$\frac{1}{d^2} = \frac{1}{\sin^2 \beta} \left(\frac{h^2}{a^2} + \frac{k^2 \sin^2 \beta}{b^2} + \frac{l^2}{c^2} - \frac{2 hl \cos \beta}{ac} \right) \dots (4.1)$$

Monochromatic x-rays of wavelength λ striking a three dimensional crystal at an arbitrary angle of incidence will not in general be reflected, as the likelihood of satisfying Laue's diffraction condition in that arbitrary orientation is very very small. Therefore, to satisfy these conditions, scanning is carried out with respect to either wavelength λ or angle of incidence θ . In this work a diffractometer with CuK_α radiation and a nickel filter was used and the various orientations of the crystallites contained in the fine powder samples constituted the scanning agent along with the rotation of goniometer through θ .

2.5.2 XRD patterns and lattice parameters :

The XRD patterns of our samples, obtained from 'Regional Sophisticated Instrumentation Centre, Nagpur', are shown in Figures 2.3 to 2.6. The pronounced peaks have been indexed using ASTM data.

The well defined x-ray diffractogram peaks show a

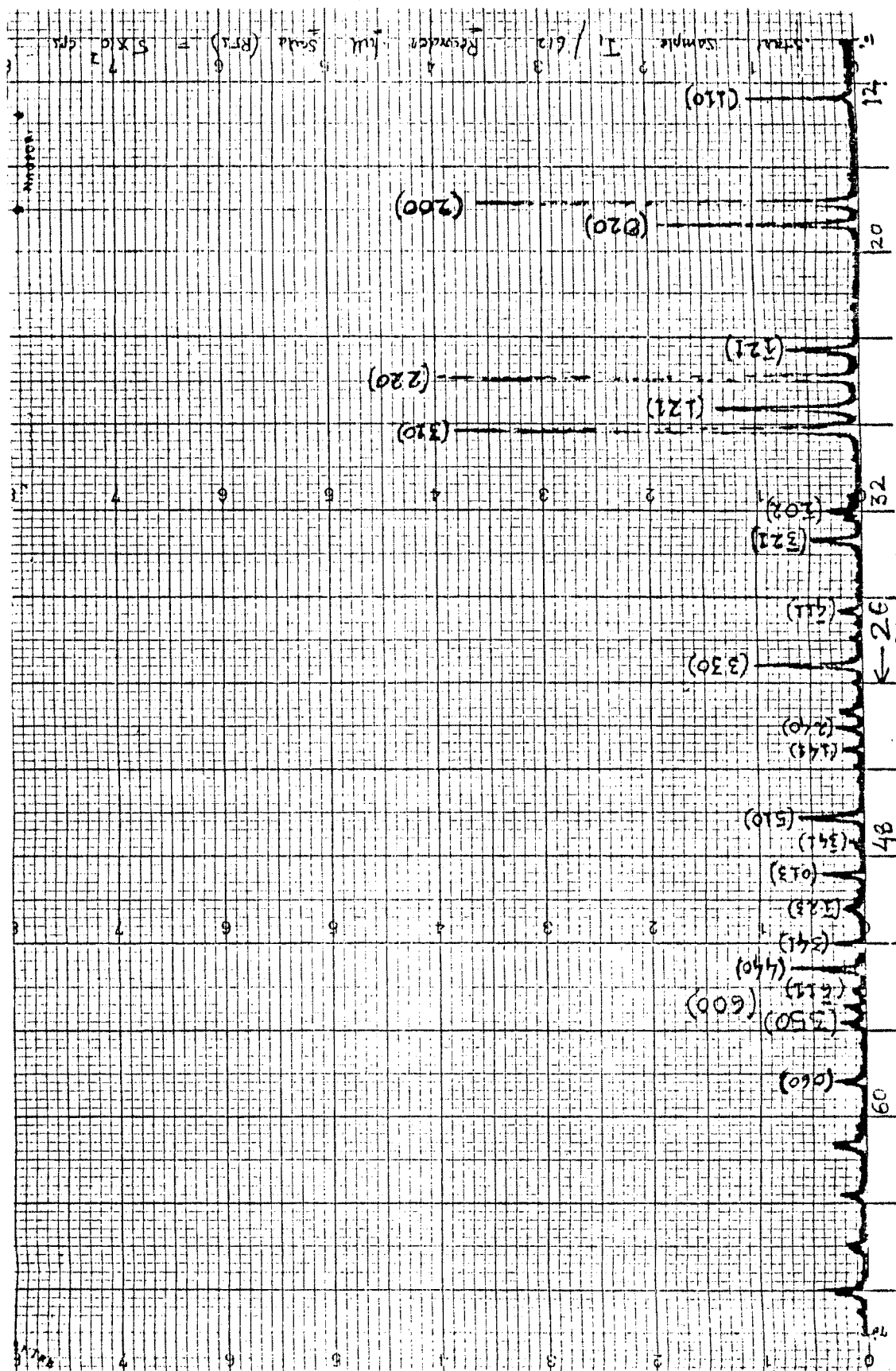

FIG. 2.3 : X-RAY DIFFRACTION PATTERN OF NAVO₃

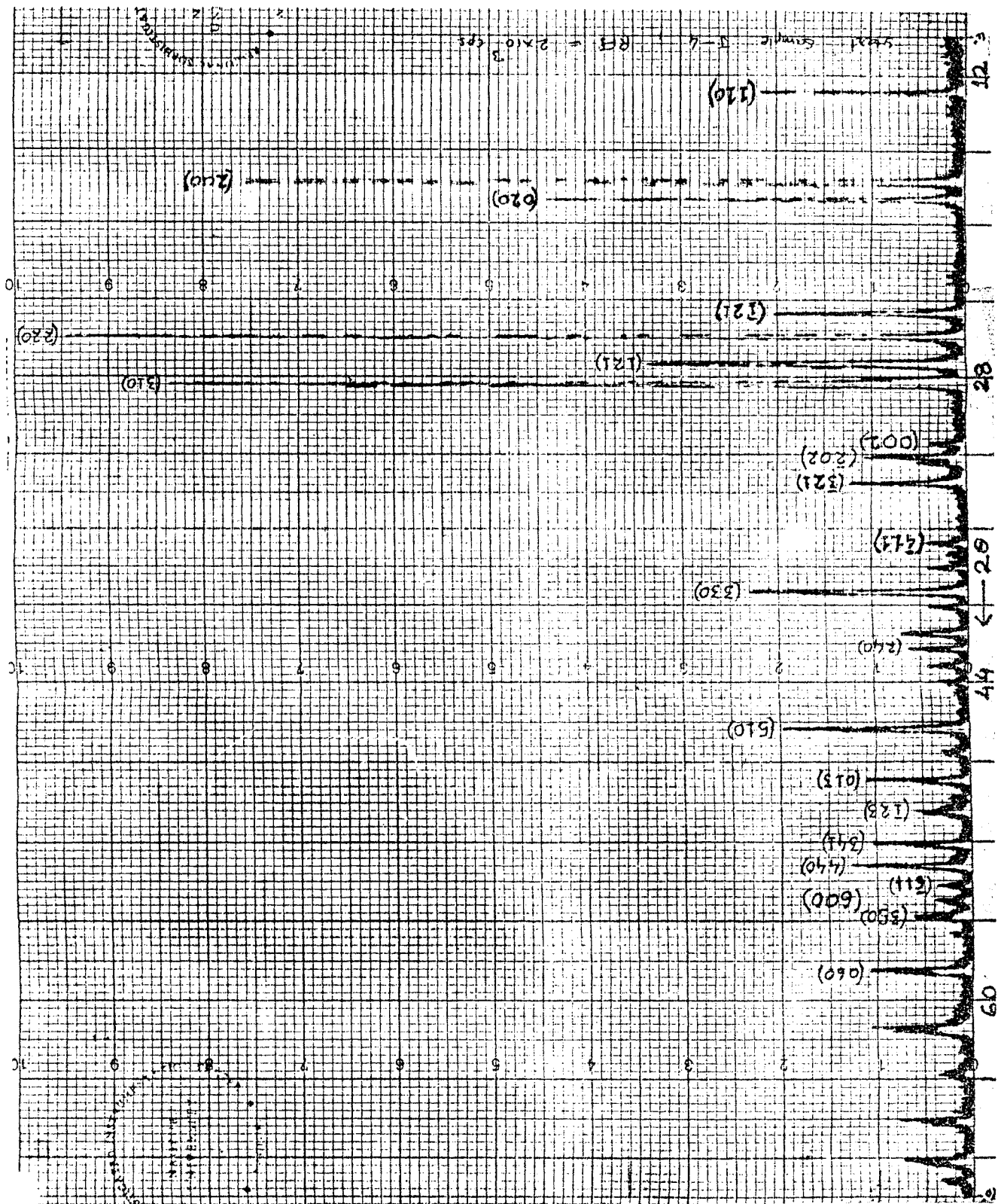

FIG. 2.4 : X-RAY DIFFRACTION PATTERN OF 0.5 MOL % Fe_2O_3 - DOPED $NaVO_3$

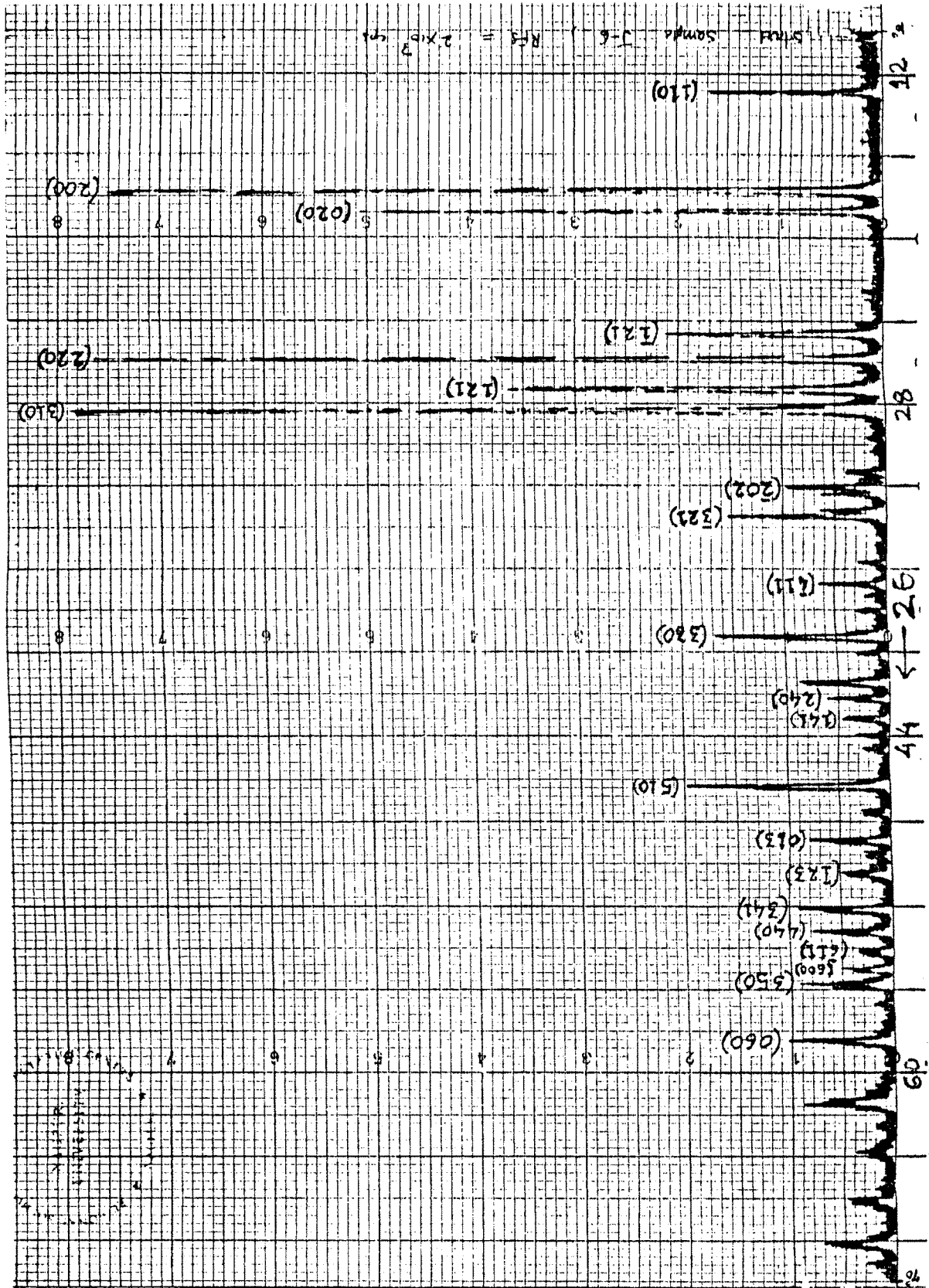

FIG. 2.5 : X-RAY DIFFRACTION PATTERN OF NaVO₃ DOPED WITH 3.0 MOL % Fe₂O₃

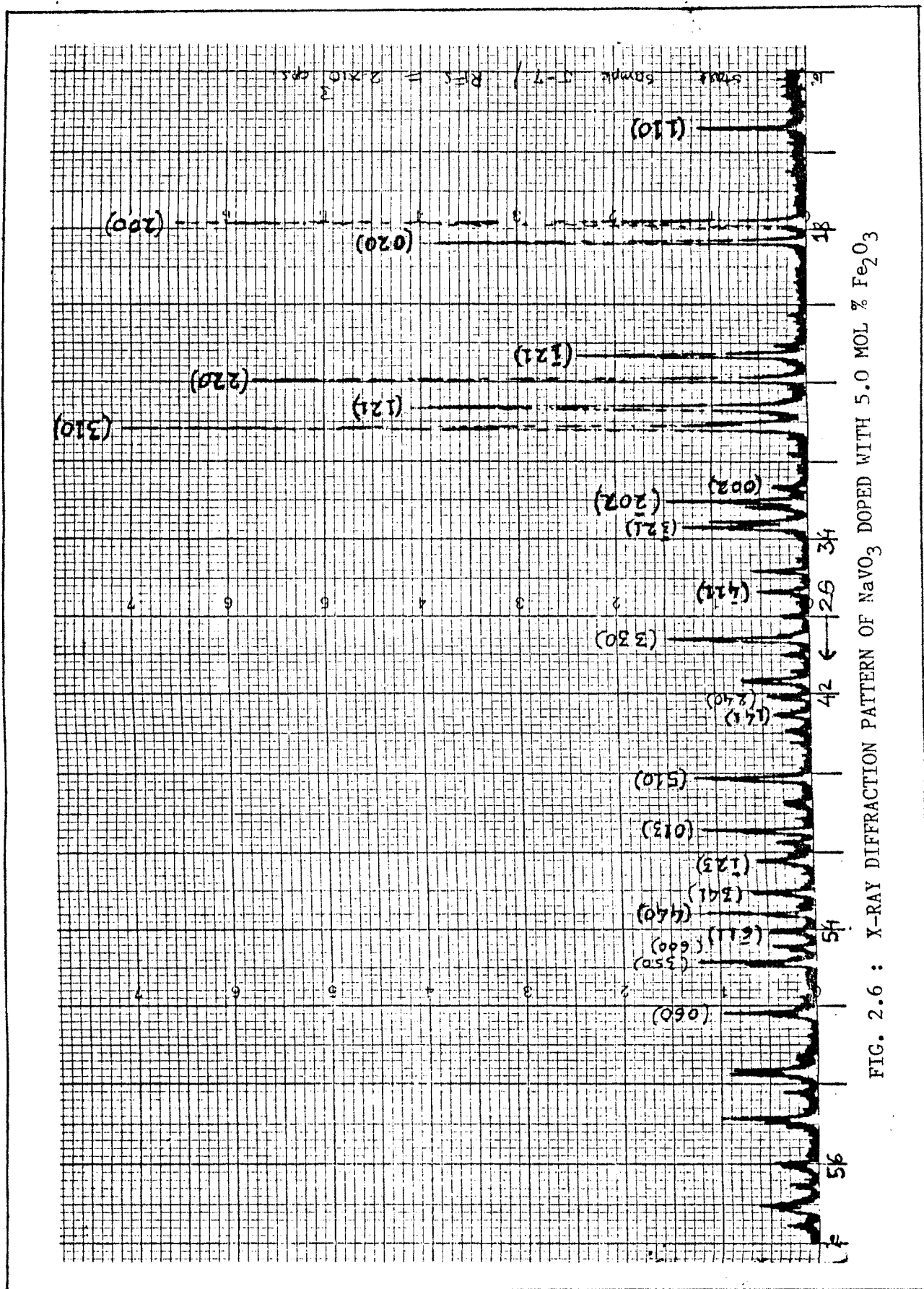

FIG. 2.6 : X-RAY DIFFRACTION PATTERN OF NaVO₃ DOPED WITH 5.0 MOL % Fe₂O₃

perfect crystalline nature of our samples. From the indexed (Fig.2.3) planes, the monoclinic structure of NaVO_3 is indicated. In Table 2.1 the calculated lattice parameters of our samples are given. The calculated lattice parameters of NaVO_3 are found to be in good agreement with the results reported by Ramani et al (1975), Sorum (1943) and Feigelson et al (1972). The XRD patterns of NaVO_3 doped with Fe_2O_3 of 0.5, 3.0 and 5.0 mol% ^{as representatives} are shown in Fig. 2.4 to 2.6. It is found that (Table 2.2) there is no appreciable change in the lattice parameters with increasing addition of Fe_2O_3 in NaVO_3 . This is but expected in view of similar size of V and Fe (III period transition elements), which most probably is the substitution. However, the effect on the peak intensities cannot be explained away by the increasing atomic scattering factor of Fe, the doping element. Detailed structural analysis involving position parameters of atoms in unit cells and their contribution to geometric scattering factors of various planes vis-a-vis the observed intensities is necessary for meaningful results. The values of d , 2θ and (h,k,l) for NaVO_3 and for the samples of 0.5, 3.0 and 5.0 mol% solute content, as representative ones, are given in Tables 2.3 to 2.6.

2.6 Microstructure Studies :

There has been considerable advance in the understanding of structure i.e. phase composition, symmetry and distribution of the solid through microstructure studies.

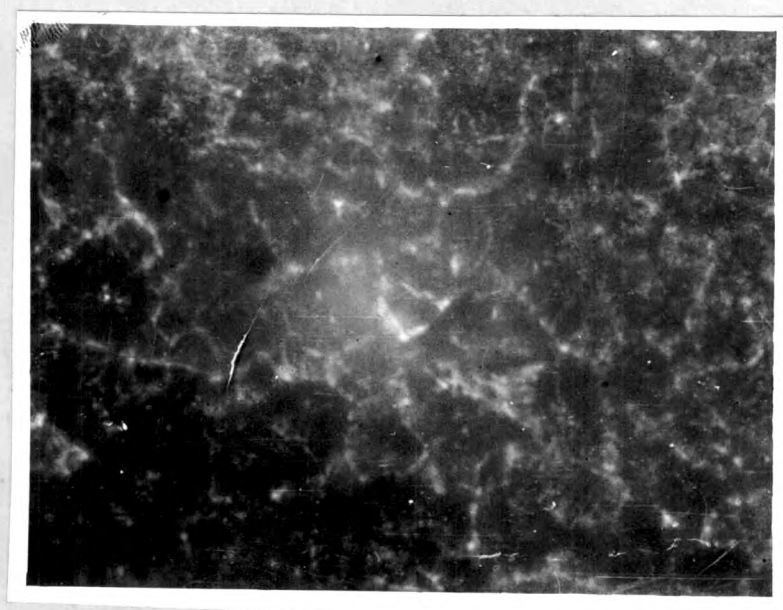

PLATE - 2.1

TABLE - 2.1

Lattice parameters of NaVO_3

Lattice parameters	Source				Remarks if any
	Ramani et al (1975)	Sorum et al (1943)	Feigelson et al (1972)	Authors results	
a (A°)	10.494	10.14	10.530	10.32	Fair agreement
b (A°)	9.434	9.45	9.465	9.45	Good agreement
c (A°)	5.863	5.86	5.864	5.86	Good agreement
β	$108^\circ 48'$	$110^\circ 2'$	$108^\circ 13'$	105°	Fair agreement

TABLE - 2.2

Lattice parameters of NaVO_3 doped with Fe_2O_3
of different mol %

Fe_2O_3 content (mol %)	a (A°)	b (A°)	c (A°)	Remarks
	(Lattice parameters)			
0.025	10.36	9.47	5.88	Slight change
0.1	10.38	9.47	5.89	
0.5	10.33	9.47	5.88	
1.0	10.34	9.46	5.86	Virtually no change
3.0	10.35	9.47	5.86	
5.0	10.33	9.47	5.87	

TABLE - 2.3

Values of d , 2θ and (hkl) for NaVO_3

2θ degree	d (\AA°)	(hkl)	Relative Intensity in arbitrary units (height)	Remarks if any
12.902	6.8614	110	26.0	
17.746	4.9979	200	90.0	
18.775	4.7263	020	48.0	
24.685	3.6065	$\bar{1}21$	17.0	
25.923	3.4371	220	100.0	
27.382	3.2572	121	34.0	
28.367	3.1462	310	96.0	
31.434	2.8459	002	-	Shoulder unresolved
32.071	2.7909	$\bar{2}02$	9.0	
33.460	2.6781	$\bar{3}21$	12.0	
36.760	2.4449	$\bar{4}11$	6.0	
39.276	2.2937	330	26.0	
39.370	2.2886	202	-	Shoulder unresolved
42.209	2.1410	240	7.0	
43.169	2.0956	141	5.0	
46.330	1.9596	510	16.0	
47.502	1.9141	$\bar{3}41$	4.0	
48.933	1.8614	013, 150	10.0	
50.521	1.8066	$\bar{1}23$	5.0	
52.120	1.7548	341, 431	8.0	
53.232	1.7208	440	18.0	
54.231	1.6914	$\bar{6}11$, 530	3.0	
55.010	1.6693	600	5.5	
55.789	1.6478	350	6.6	
58.447	1.5790	060	7.7	

TABLE - 2.4

Values of d , 2θ and (hkl) for NaVO_3 doped with Fe_2O_3 of 0.5 mol %

2θ degree	d (\AA)	(hkl)	Relative intensity in arbitrary units (height)
12.969	6.8261	110	23.21
17.804	4.9818	200	80.17
18.837	4.7108	020	46.41
24.742	3.5984	$\bar{1}21$	23.62
25.982	3.4293	220	100.00
27.415	3.2533	121	35.44
28.433	3.1391	310	88.61
31.487	2.8413	002	4.22
32.115	2.7871	$\bar{2}02$	11.34
33.523	2.6732	$\bar{3}21$	12.87
36.794	2.4427	$\bar{4}11$	4.64
39.339	2.2904	330	24.26
42.274	2.1379	240	6.75
46.368	1.9582	510	21.10
48.969	1.8601	013,150	13.39
50.483	1.8078	$\bar{1}23$	6.33
52.170	1.7533	341,431	10.97
53.279	1.7194	440	13.08
54.263	1.6903	$\bar{6}11,530$	3.78
55.038	1.6685	600	4.22
55.820	1.6470	350	6.33
58.486	1.5781	060	11.34

TABLE - 2.5

Values of d , 2θ and (hkl) for NaVO_3 doped with Fe_2O_3 of 3.0 mol %

2θ degree	d (\AA)	(hkl)	Relative Intensity in arbitrary units (height)
12.886	6.8699	110	21.34
17.736	5.0007	200	96.45
18.754	4.7316	020	64.47
24.568	3.6090	$\bar{1}21$	29.44
25.914	3.4382	220	96.70
27.340	3.2621	121	46.45
28.356	3.1474	310	100
32.055	2.7922	$\bar{2}02$	12.18
33.438	2.6798	$\bar{3}21$	19.54
36.747	2.4457	411	8.38
39.265	2.2945	330	21.34
42.175	2.1427	240	7.61
43.145	2.0967	141	5.84
46.321	1.9601	510	25.38
48.915	1.8621	013,150	10.15
50.449	1.8090	$\bar{1}23$	6.09
52.113	1.7550	341,431	8.63
53.222	1.7211	440	10.15
54.093	1.6954	$\bar{6}11,530$	4.57
54.999	1.6696	600	6.60
55.775	1.6482	350	11.67
58.426	1.5796	060	13.19

TABLE - 2.6

Values of d , 2θ and (hkl) for NaVO_3 doped with
 Fe_2O_3 of 5.0 mol %

2θ degree	d (\AA)	(hkl)	Relative intensity in arbitrary units (height)
12.915	6.8545	110	16.29
17.757	4.9948	200	91.57
18.785	4.7239	020	56.18
24.694	3.6053	$\bar{1}21$	33.71
25.934	3.4356	220	80.90
27.352	3.2607	121	57.87
28.376	3.1453	310	100
31.386	2.8502	002	5.34
32.109	2.7876	$\bar{2}02$	9.27
33.462	2.6780	$\bar{3}21$	17.98
36.723	2.4473	$\bar{4}11$	7.87
39.281	2.2936	330	17.98
42.213	2.1408	240	8.99
43.194	2.0945	141	5.62
46.327	1.9598	510	16.85
48.940	1.8612	013,150	16.29
50.449	1.8090	$\bar{1}23$	7.86
52.125	1.7548	341,431	9.55
53.232	1.7208	440	15.73
54.251	1.6908	$\bar{6}11,530$	7.02
54.996	1.6697	600	6.46
55.791	1.6477	350	17.41
58.453	1.5789	060	13.48

Optical microscopy helped to a large extent in carrying out microstructure studies, during the last few decades. Recently it has become clear that not only mechanical strength but other properties as well (thermal, electrical, magnetic and thermoelectric etc.) depend to a considerable extent on ceramic microstructure and that this microstructure has other important aspects apart from porosity and the number of phases. These aspects include the size of constituent crystallites, the boundaries between them, domain structure, inclusions and texture.

We have carried out optical microscopy at 450 magnification, in order to gauge the microstructure features. Plate 2.1 shows the micrograph of the sample NaVO_3 doped with 1.0 mol % of Fe_2O_3 , as a representative sample. The look at high magnification showed that the samples of NaVO_3 doped with 1.0, 3.0 and 5.0 mol% of Fe_2O_3 contain reddish spots in the structure. These spots correspond to small inclusions of solute material at these concentrations (1.0 to 5.0 mol %) of Fe_2O_3 . While the structure of NaVO_3 doped with Fe_2O_3 from 0.025 to 0.5 mol % shows no traces of red spots. This indicates that 0.5 mol % concentration of Fe_2O_3 is most probably the limit of solid solubility in NaVO_3 . This might also provide an explanation for virtually unchanged lattice parameters of the samples containing Fe_2O_3 greater than 0.5 mol % concentration.



REFERENCES

- Feigelson R.S. and Martin G.W. J.Crystal Growth, 13/14, 686 (1972).
- Glazyrin M.P. and Fotiev A.A. Sov. Phys. Crystalloger, 9, 226 (1964).
- Godefrog G. and Duman C. et al. Ferroelectrics (GB), 37, No.1-4, 725 (1981).
- Hawthorne F.C. and Calvo C. J.Solid State Chem. 22, 157 (1977).
- Patil T.A., Jamadar V.M. and Chavan S.H. Indian J. Phys., 62A, 341 (1988a).
- Patil T.A., Jamadar V.M. and Chavan S.H. Indian J. Pure and Appl. Phys., 26, 456 (1988b).
- Ramani K. and Shaikh A.M. Ferroelectrics, 9, 49 (1975).
- Seetharam S., Bhat H.L. and Narayanan P.S. J.Raman Spectroscopy, 14, No.6, 401 (1983).
- Shaik A.M., Viswamitra M.A. and Narayanan P.S. Ferroelectrics (USA), 20, 311 (1978).
- Sorum H. Kgl.Norske. Videnskab. Selskabs, Forch; 16, 39 (1943).
